

4

Designing a Quilt Block



Learning Goals

- name, describe, and classify angles
- estimate and determine angle measures
- draw and label angles
- provide examples of angles in the environment
- investigate the sum of angles in triangles and quadrilaterals



Polygons

The Heritage Park Historical Village in Calgary, Alberta, hosts *A Festival of Quilts* each May. It is Western Canada's largest outdoor quilt show.



Key Words

angle

arm

right angle

straight angle

acute angle

obtuse angle

reflex angle

protractor

standard protractor

degree

interior angle

diagonal

Look at these quilts.

- What shapes do you see?
- Which shapes have sides that are perpendicular? How do you know?

1

Naming Angles

An **angle** is formed when 2 lines meet.

You can think of an angle as a turn about a vertex. The angle shows how far one **arm** is turned to get to the other arm.

The hour hand and the minute hand on a clock form an angle at the centre of the clock. What angle is formed by the hands on this clock?

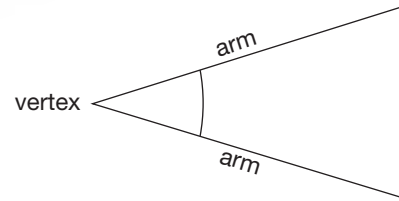

Explore



You will need a drinking straw and grid paper.

To make an angle:

- Place the straw horizontally on the grid paper.
 - Trace the bottom edge of the straw to make one arm.
 - Use one end of the straw as the point of rotation. Rotate the straw.
 - Trace the bottom edge of the rotated straw to make the other arm.
- Rotate the straw. Draw each angle:
- a right angle
 - an angle less than a right angle
 - an angle greater than a right angle
- Trade drawings with another pair of students. Find a way to check their angles.



Show and Share

Compare the strategies you used to check the angles.

Which strategy worked best?

Did the length of the lines you drew affect the size of the angle?

Connect

Right angles and **straight angles** are all around us.



We name angles for the way they relate to a right angle or a straight angle.

An **acute angle** is less than a right angle.

An **obtuse angle** is greater than a right angle, but less than a straight angle.

A **reflex angle** is greater than a straight angle.

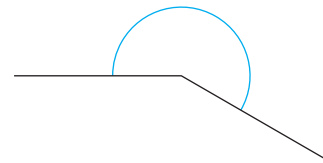
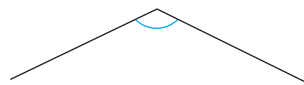
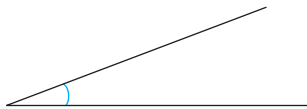

Practice

Use a piece of paper with a square corner when it helps.

1. Which angle is an acute angle? A right angle? An obtuse angle? A straight angle? A reflex angle?

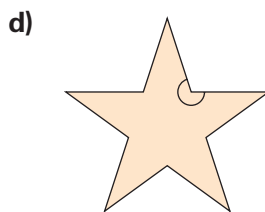

2. Name each angle as a right angle, an acute angle, an obtuse angle, a straight angle, or a reflex angle. How did you find out?

a)

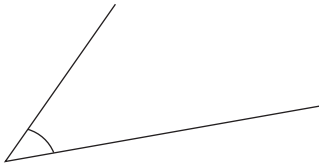

b)

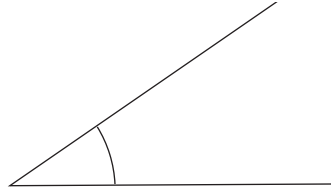

c)



d)

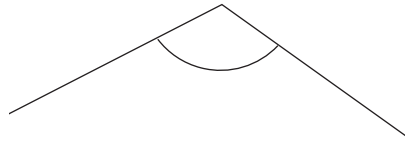

e)



f)

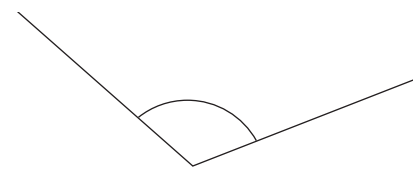

g)

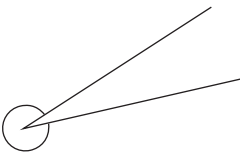

h)



i)

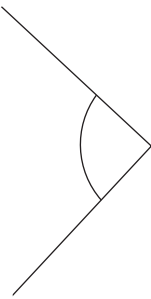

j)

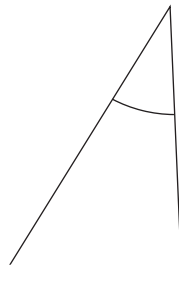

3. Your teacher will give you a large copy of these flags.

List the flags with:

a) a right angle

b) an acute angle

c) an obtuse angle

d) a reflex angle

On each flag, label an example of each type of angle you find.



British Columbia



Saskatchewan



Nunavut



Canada

4. Draw a line segment on grid paper.
 Visualize rotating the line segment about one of its end points.
 Which type of angle is formed by each rotation?
- a) a $\frac{1}{2}$ turn
 - b) a $\frac{1}{4}$ turn clockwise
 - c) a $\frac{3}{4}$ turn counterclockwise
- Use tracing paper to check.

5. a) For each time below, which type of angle is formed by the hour hand and minute hand on a clock?
 How did you find out?
- i) 2:15
 - ii) 3:35
 - iii) 9:00
 - iv) 12:30
 - v) 1:45
- b) Would the size of each angle change if the minute hand was shorter?
 Justify your answer.

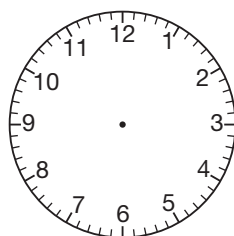

Steam Clock, Gastown, Vancouver



6. Find 5 angles in your classroom.
 Try to find one example of a right angle, an acute angle, an obtuse angle, a straight angle, and a reflex angle.
 Sketch each angle.
 Write where you found each angle, then label the angle with its name.
 How did you decide how to name each angle?
 Which angle was easiest to find?
 Why do you think so?

7. Use square dot paper.
 How many different angles can you draw on a 3-by-3 grid?
 Classify the angles.
 Show your work.



Reflect

When you see an angle, how can you tell which type of angle it is?
 How many ways can you find out?
 Use words and pictures to explain.

2

Exploring Angles

These angles are both acute.
Describe the angles.

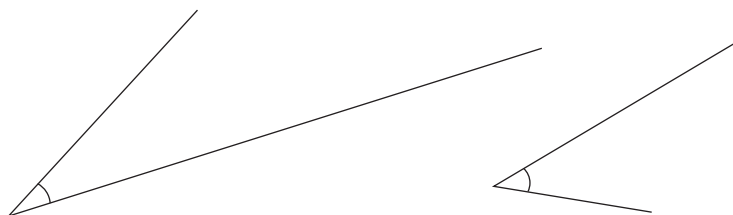

Explore



You will need Pattern Blocks, an index card, a ruler, and scissors.

- Use a ruler to draw an acute angle on the card. Cut out the angle.
- Use the cutout as a unit of angle measure. Choose the green triangle. Estimate how many times your angle unit will fit in each of its angles. Measure each angle of the green triangle with your angle unit. Record your measure in a table. Repeat with each of the other Pattern Blocks.



Pattern Block	Angle Measure (units)

Show and Share

Compare your angle measures with those of another pair of students. Did you get the same measures for the same block? Explain. What could you do so everyone does get the same measures for the same block?

Connect

We can use a square piece of tracing paper or wax paper to make an angle measurer. The angle measurer is called a **protractor**.

- Carefully fold the paper in half and make a crease along the fold. Fold the paper in half again so the folded edges meet. Make a crease. Fold in this way one more time. Cut or tear as shown.

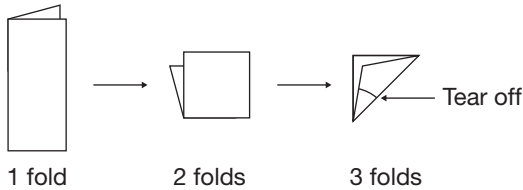

Open up the paper. It should look like this:

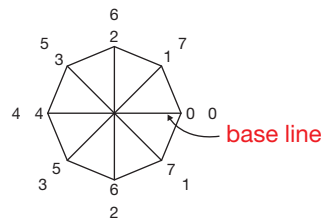

The protractor is divided into 8 equal slices. Each slice is 1 unit of angle measure. Label the slices from 0 to 7 clockwise and counterclockwise.

- To measure this angle, count how many units fit the angle:
 - Place the protractor on the angle.
 - Line up one arm of the angle with the base line of the protractor. The vertex of the angle is at the centre of the base line.
 - Use the scale, starting at 0, to count the units that fit between the arms.

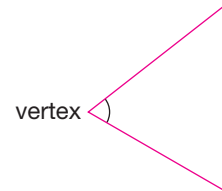

The angle is between 1 unit and 2 units.
The angle is about 1.5 units.

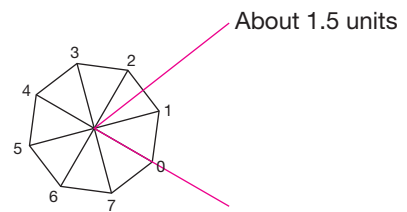

Practice

You will need an 8-unit protractor.

- Use your protractor to measure the angles in:

a) the yellow hexagon	b) the blue rhombus	c) the red trapezoid
d) the orange square	e) the green triangle	f) the tan parallelogram

Record your measures.

3

Measuring Angles

In Lesson 2, you used an 8-unit protractor to measure angles.

To measure angles more accurately, we use a **standard protractor**.

The standard protractor divides a straight angle into 180 congruent slices.

Each slice is 1 **degree**. We write 1° .

The protractor shows angle measures from 0° to 180° .

From now on, we will refer to a standard protractor as a protractor.

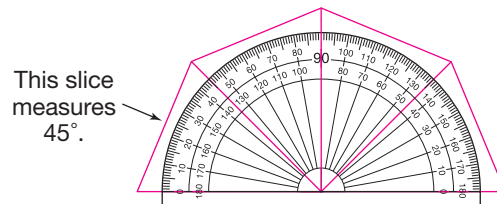

What is the measure of each angle?

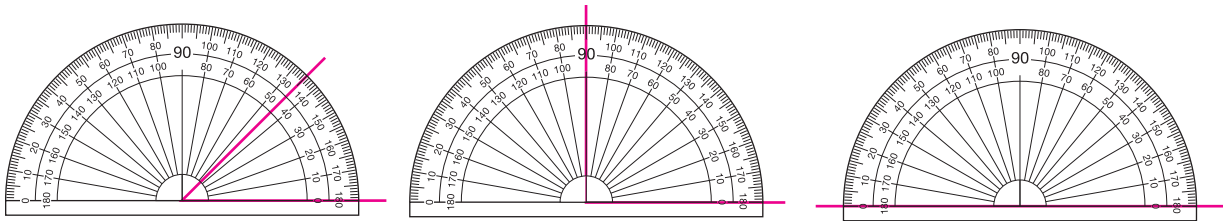

Explore



You will need a ruler.

- Use a ruler to draw an angle.
- Have your partner:
 - use the 45° , 90° , and 180° angles above as reference angles to estimate the size of the angle
 - record the estimate
- Trade roles. Continue until you have 6 different angles. Try to make angles that are acute, right, and obtuse.
- Order the estimates from least to greatest.

Show and Share

Share your work with another pair of students.

How did you estimate the size of each angle?

How did the estimate of one angle help you estimate the measure of another angle?

Connect

A protractor has 2 scales so that we can measure angles opening different ways.

- To measure this angle using a protractor:

Step 1

Place the protractor on top of the angle.

The vertex of the angle is at the centre of the protractor.

One arm of the angle lines up with the base line of the protractor.

Step 2

Find where the other arm of the angle meets the protractor.

Since the arm along the base line passes through 0° on the inner scale, use the inner scale.

Follow the inner scale around.

The angle measures 60° .

- This diagram shows when you would use the outer scale to measure an angle.

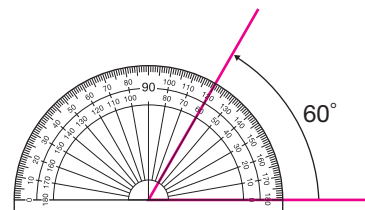
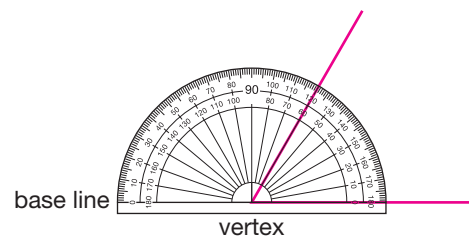
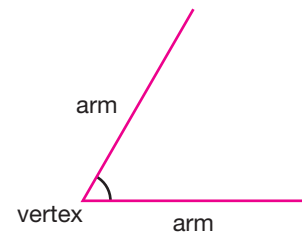
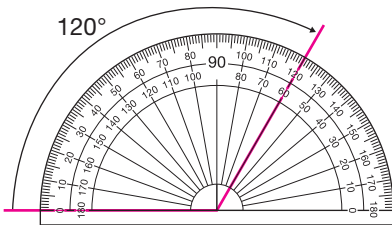

Since the arm along the base line of this angle passes through 0° on the outer scale, use the outer scale. The angle measures 120° .

- We can use a protractor to measure this reflex angle. A reflex angle is the outside angle of an acute, right, or obtuse angle.

Step 1

Use the protractor to measure the inside angle.
The inside angle measures 135° .

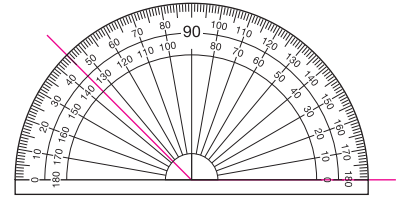
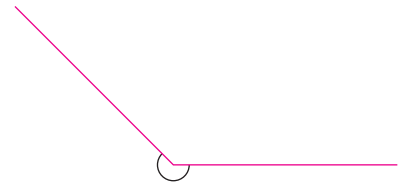

Step 2

A complete turn is 360° .

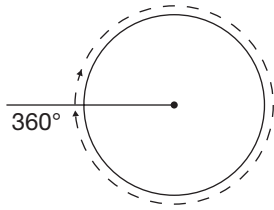

To find the measure of the reflex angle, we subtract:
 $360^\circ - 135^\circ = 225^\circ$

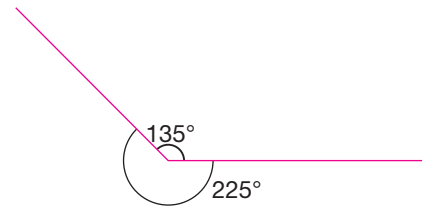

- We name angles according to their measures in degrees.

The measure of an **acute angle** is less than 90° .

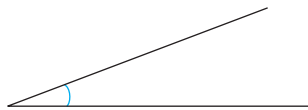

The measure of a **right angle** is 90° .



The measure of an **obtuse angle** is between 90° and 180° .

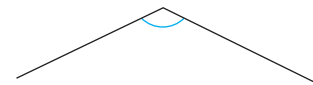

The measure of a **straight angle** is 180° .



The measure of a **reflex angle** is between 180° and 360° .

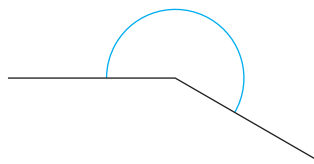

The measure of one-half a right angle is 45° .

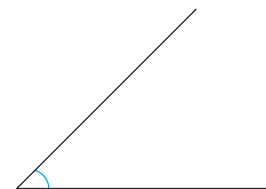

To estimate the measure of an angle, we can use 45° , 90° , and 180° as reference angles.

Practice

1. What is the measure of each angle? Explain how you know.

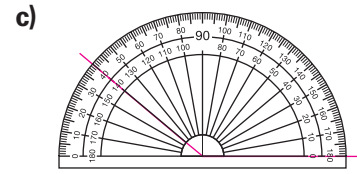
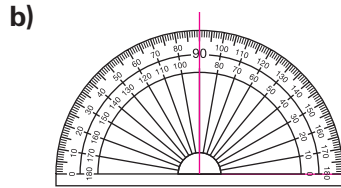
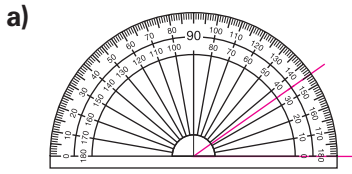

2. For each angle:

- Choose an appropriate reference angle: 45° , 90° , 180°
Estimate the size of the angle.
- Use a protractor to find the angle measure.
How close was your estimate to the actual measure? Explain.
- Name each angle as acute, right, obtuse, or straight.

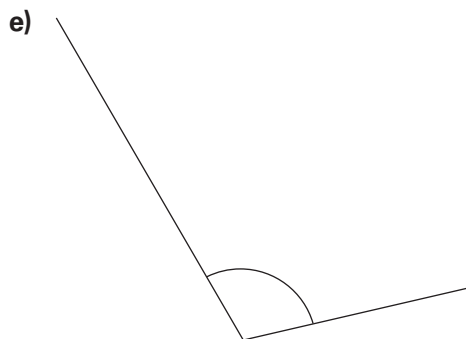
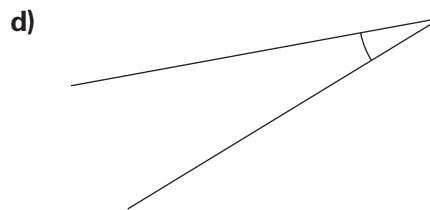
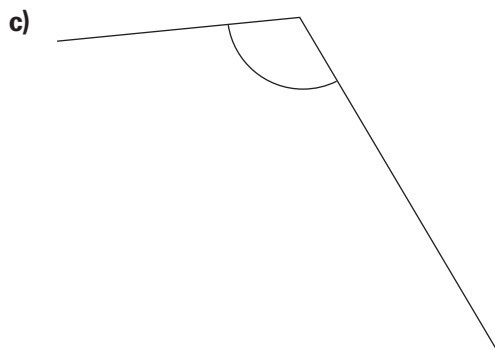
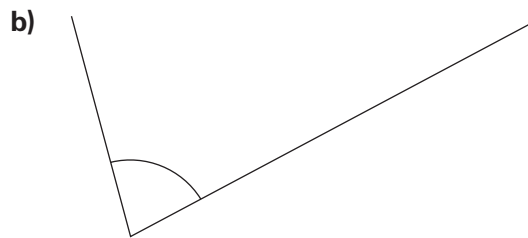
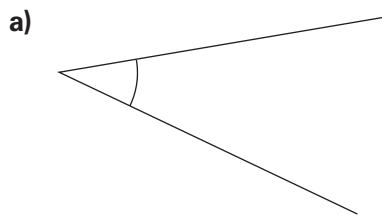

3. Which of these angles do you think measures 45° ?
Check your estimates with a protractor. What did you find out?

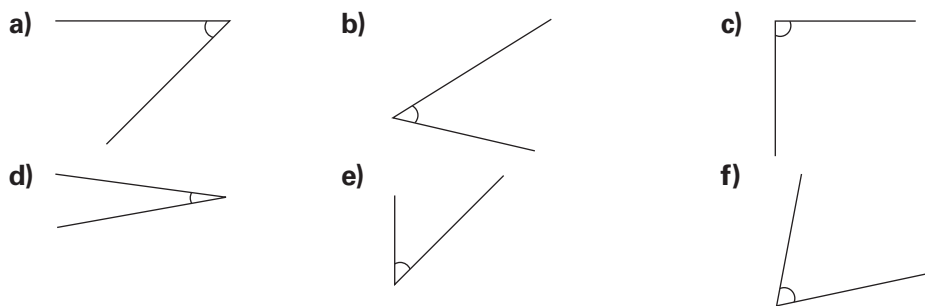

4. Measure each angle.
Do the angles in each pair have the same measure?

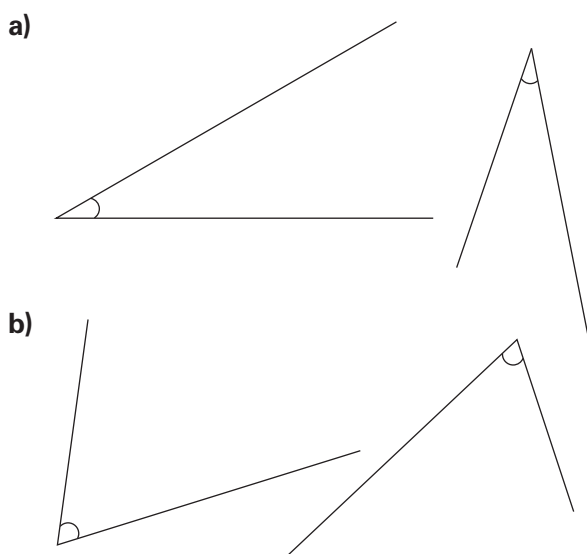

Do the lengths of the arms affect the measure of the angle? Explain.
Does the position of the angle affect the measure? Explain.

5. How can you tell whether you used the correct scale on the protractor to measure an angle?
Include an example in your explanation.

6. Use a protractor to find the measure of each reflex angle.
How can you check that your measure is correct?

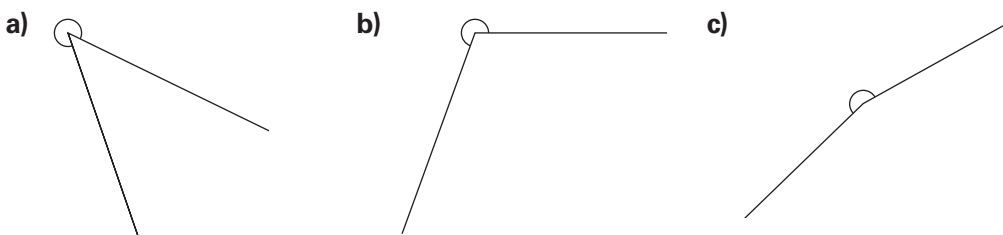



7. Use a protractor to solve each riddle.

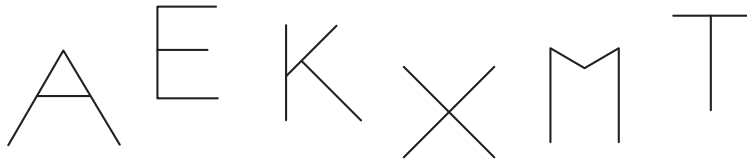

- a) I have 4 equal angles.
Each angle measures 90° .
Which letter am I?
- b) I do not have any angles that
measure 90° .
I have 3 angles that measure 60° .
I have 2 angles that measure 120° .
Which letter am I?
- c) I have 2 right angles.
I have 1 acute angle.
I have 1 obtuse angle.
Which letter am I?
- d) Make up your own letter riddle.
Trade riddles with a classmate.
Solve your classmate's riddle.



8. Name 4 objects in your classroom that have:
- a) an angle greater than 100°
 - b) an angle less than 60°
- Use a protractor to check your answers.

9. A student measured this angle and said it measured 60° .
Do you agree? Explain.

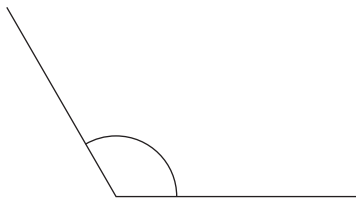

At Home



Reflect

How can you use a piece of paper to help estimate the measure of an angle?

Look around your home for examples of angles with different sizes. Sketch each angle and estimate its measure.

4

Drawing Angles

Without using a protractor, how could you draw a 90° angle?
A 45° angle? A 135° angle?

Explore



You will need a ruler and a protractor.

Angle Aim!

The object of the game is to draw angles as close as possible to the given measures. Decide who will be Player A and Player B.

- Player A writes an angle measure.
Without using a protractor, Player B draws an angle as close as possible to Player A's measure.
Players switch roles and repeat the activity.
- Players measure each other's angle.
The player whose angle is closer to the stated measure gets 1 point.
- Players play 4 more rounds. The player with more points after 5 rounds wins.



Show and Share

Share the strategies you used to draw your angles with your partner.
How did you use estimation to help you draw the angles?
How could you draw the angles more accurately?

Connect

To draw an angle with a given measure, we use a ruler and a protractor.

- To draw an angle that measures 145° :
 - Use a ruler. Draw a horizontal line.
Use the line as one arm of the angle.
 - Place the protractor on the arm.
One end of the arm is at the centre of the protractor.
The arm lines up with the base line of the protractor.
Start at 0° on the arm along the base line.
Count around the protractor until you reach 145° .
Make a mark at 145° .

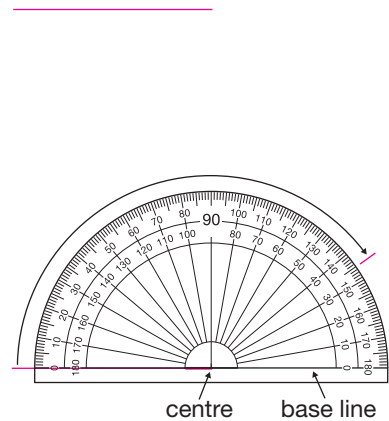

You can measure from 0° to 180° clockwise or counterclockwise. Remember to start at 0° when you draw an angle.

- Remove the protractor.
Draw a line to join the end of the arm at the centre of the protractor with the mark at 145° .
Label the angle with its measure.
- To draw an angle that measures 280° :

A 280° angle is a reflex angle.
So, draw the angle that makes up a complete turn:
 $360^\circ - 280^\circ = 80^\circ$
Then, 280° is the outside angle.

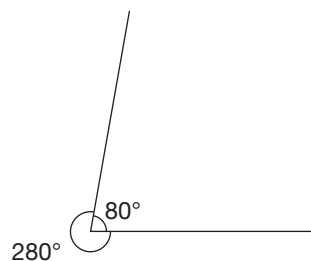

$$280^\circ + 80^\circ = 360^\circ$$

Practice

1. Use a ruler and a protractor.

Draw an acute angle with each measure.

- a) 20° b) 15° c) 75° d) 50°

2. Use a ruler and a protractor.

Draw an obtuse angle with each measure.

- a) 120° b) 155° c) 95° d) 170°

3. Use a ruler and a protractor.

Draw a horizontal line segment AB.

Each angle you draw should have its vertex at A.

- a) Using AB as one arm, draw a 70° angle.
 b) Use the line you drew in part a as one arm of another angle. Draw a 55° angle.
 c) Use the line you drew in part b as one arm of another angle.
 Draw a 105° angle.
 d) Without using a protractor, find the measure of the angle formed by the horizontal line and the line you drew in part c.
 How did you find out? Measure to check.



4. Use only a ruler to draw an angle that you think measures:

- a) 90°
 b) a little less than 90°
 c) about 45°
 d) a little more than 90°
 e) a little less than 180°

How can you check to see if you are correct?

Show your work.





5. Copy these line segments. Use a ruler and a protractor.

Using each line as one arm, draw a 50° angle.

Label each angle with its measure.

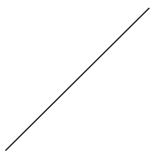
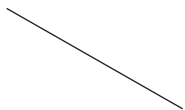
How did you decide which scale to use?

- a)  b)  c)  d) 

6. Use a ruler and a protractor.
Draw an angle with each measure.
- a) 205° b) 200° c) 270°
d) 320° e) 350° f) 300°
7. Draw an acute angle. Without using a protractor, draw an angle that is 90° greater than the angle you drew.
Measure the angle with a protractor to check.
Explain how you drew the angle.
8. a) Without using a protractor, draw a 90° angle.
How can you use this angle to draw a 180° angle?
How are the two angles related?
b) Without using a protractor, draw a 180° angle.
How can you use this angle to draw a 90° angle?
A 45° angle?
How are the three angles related?
Show your work.
9. a) Draw an obtuse angle.
Use a protractor to find its measure.
Label the angle with its measure.
b) Use tracing paper to copy the angle.
Rotate the angle $\frac{1}{4}$ turn clockwise about its vertex.
Measure the angle. What do you notice?
c) Choose a different rotation.
Predict what would happen to the size of the angle under this rotation.
Rotate the angle to check. How can you explain this?
10. Is it possible to draw a reflex angle so the other angle formed by the arms is:
- a) acute? b) obtuse? c) straight?
Use examples to explain.

Math Link

Science

It takes about 365 days for the Earth to make one complete revolution around the Sun. The number of degrees in a complete turn is 360° . So, the Earth travels about 1° around the Sun each day.

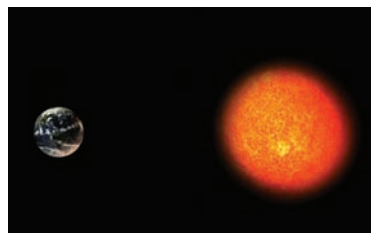

Reflect

Explain how to use a protractor to draw an angle of 315° .
Use words and pictures to explain.
How could you draw an angle of 315° without using a protractor?

Angle Hunt



Angles and shapes are everywhere.

In this game, you search for angles and shapes in your classroom.

You will need a protractor, a ruler, a pencil, paper, and game cards.

Work in a group of 4.

- ▶ Shuffle the game cards.
Place the cards face down in the centre of the table.
Decide who will go first.
- ▶ Player 1 draws a card.
She looks for an object in the classroom that matches the description.
If a sketch card is drawn, she sketches a shape with the attribute.
Each shape may only be used once.
The other players identify the object and check that Player 1 is correct.
If the answer is correct, Player 1 keeps the card and it is the next player's turn.
If the answer is incorrect, the card is passed to the next player to try.
The card is passed until it is answered correctly.
- ▶ Players take turns until all the cards have been drawn.
The player with the most cards is the winner.



Strategies Toolkit

Explore

Draw a pentagon with:

- no lines of symmetry
- exactly one obtuse angle
- exactly one pair of parallel sides

Is Paolo's solution correct? How do you know?
If Paolo's solution is not correct, describe how he could change the shape so his solution is correct.

Show and Share

Share your work with a classmate.
Is it possible to draw more than one shape to solve this problem? Explain.

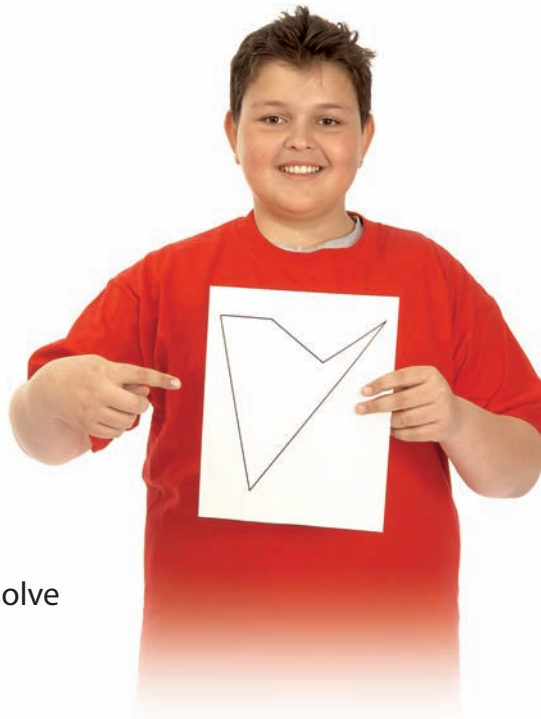

Connect

➤ Marg drew this shape to solve the problem below.

Draw a pentagon with:

- at least one reflex angle
- at least one right angle
- no parallel sides

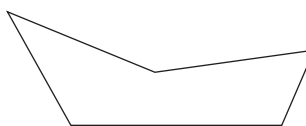

Strategies for Success

- Check and reflect.
- Focus on the problem.
- Represent your thinking.
- Explain your thinking.

Marg checked that the shape she drew meets all the criteria.

- | | |
|---|-----|
| • The shape is a pentagon. | Yes |
| • The shape has at least one reflex angle. | Yes |
| • The shape has at least one right angle. | No |
| • The shape does not have any parallel sides. | Yes |





Marg's shape is a pentagon with at least one reflex angle, no right angles, and no sides parallel. She must change the shape to include at least one right angle.

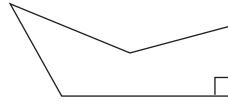

► When you solve problems, always check your solution.

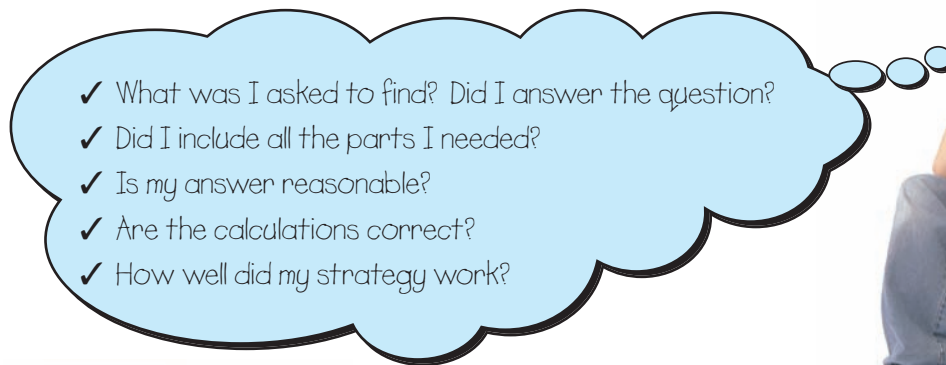

Practice

1. Find the mystery attribute.
Show how you checked your answer.

All of these have it.	None of these has it.	Which of these has it?

2. Draw a quadrilateral with:

- no lines of symmetry
- exactly one pair of parallel sides
- exactly two right angles
- exactly one obtuse angle

What shape have you drawn?

Reflect

Why is it important to always check your solution?

6

Investigating Angles in a Triangle

Without using a protractor, what is the measure of angle A?
How do you know?

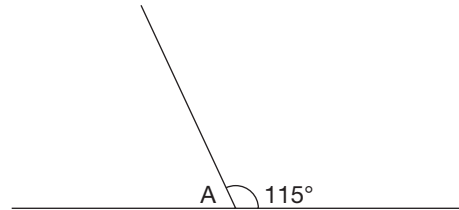

Explore



You will need a ruler, scissors, and a protractor.

➤ Draw a triangle to match each description below:

- a triangle with one right angle
- a triangle with one obtuse angle
- a triangle with all acute angles

Use a protractor to measure the angles in each triangle.

Record the measures in a table.

➤ Cut out one of the triangles. Cut off its angles.

Place the vertices of the three angles together so adjacent sides touch. What do you notice?

➤ Repeat the activity with the other two triangles.

What can you say about the sum of the angles in each triangle?

➤ Use the measures in your table.

Find the sum of the angles in each triangle.

Does this confirm your results from cutting off the angles?

Explain.

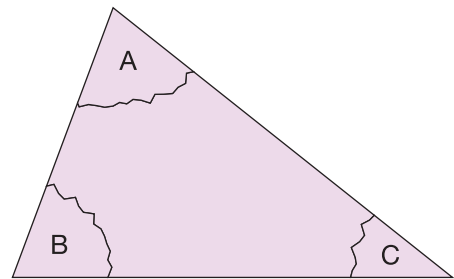

Show and Share

Compare your results with those of another pair of classmates.

What can you say about the sum of angles in a triangle?

Do you think this would be true for all triangles?

Explain your thinking.

Connect

- We can show that the sum of the **interior angles** in a triangle is the same for any triangle.

Arrange 3 congruent triangles as shown.

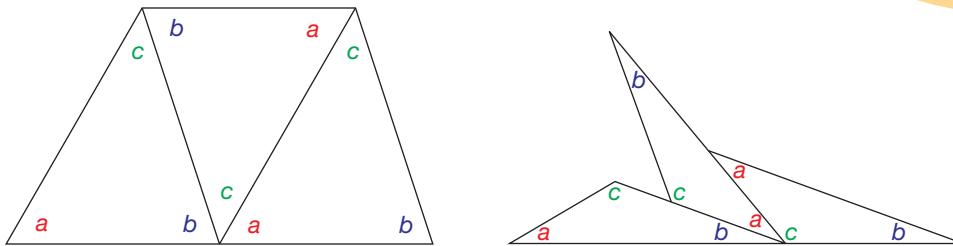

An interior angle is an angle inside a triangle or other polygon.

The arrangements show that angles a , b , and c make a straight angle.

$$\text{So, } a + b + c = 180^\circ$$

The sum of the angles in a triangle is 180° .

- We can use the sum of the angles in a triangle to find the measure of the third angle in this triangle.

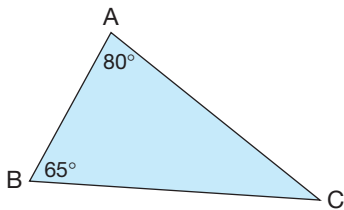

We often refer to an angle using the letter of its vertex. For example, the 80° angle in triangle ABC is $\angle A$.

The sum of the angles in a triangle is 180° .

$$\text{So, } \angle A + \angle B + \angle C = 180^\circ$$

Since $\angle A = 80^\circ$ and $\angle B = 65^\circ$,

$$80^\circ + 65^\circ + \angle C = 180^\circ \quad \text{Add the angles.}$$

$$145^\circ + \angle C = 180^\circ$$

Solve the equation by inspection.

Which number do we add to 145 to get 180?

The measure of $\angle C$ is 35° .

To check, we can find the sum of the 3 angles:

$$\begin{aligned} \angle A + \angle B + \angle C &= 80^\circ + 65^\circ + 35^\circ \\ &= 180^\circ \end{aligned}$$

So, the answer is correct.

I could count on to find out.



Practice

1. Draw 3 different triangles on dot paper. Measure and record each angle. Find the sum of the measures of the angles for each triangle.

2. Determine the measure of the third angle without measuring.

a)

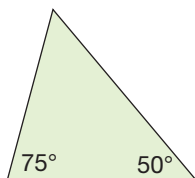

b)

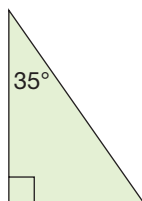

c)

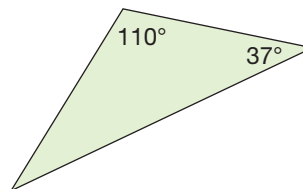

3. The two unknown angles in each triangle below are equal. Determine the measure of each unknown angle without measuring. Explain the strategy you used.

a)

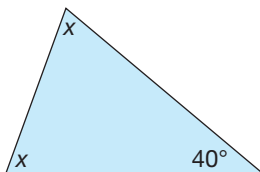

b)

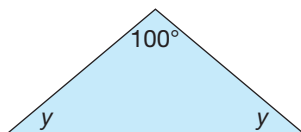

c)

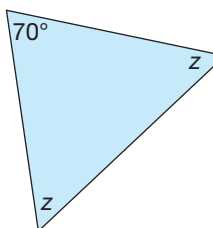

4. Two angles of a triangle are given. Find the measure of the third angle.

a) $55^\circ, 105^\circ$

b) $45^\circ, 90^\circ$

c) $30^\circ, 60^\circ$

d) $25^\circ, 125^\circ$

5. Vegreville, Alberta, is home to the world's largest known Ukrainian egg. It has 1108 triangular pieces with three angles of equal measure.

Find the measure of each angle.
Explain your strategy.

6. Is it possible for a triangle to have:

a) more than 1 obtuse angle?

b) 2 right angles?

c) 3 acute angles?

Explain your thinking.

Use pictures and words.





7. Find the measure of the third angle in each triangle described below. Then, draw the triangle.

Explain how you found each measure.

- a) A triangle with two angles measuring 65° and 55°
- b) A triangle with two equal angles; each measures 40°
- c) A right triangle with a 70° angle

8. Find the measures of the angles labelled m and n .

Explain the strategy you used.

a)

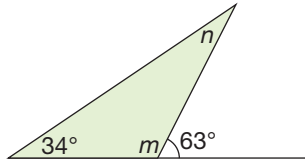

b)

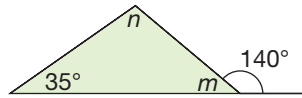

c)

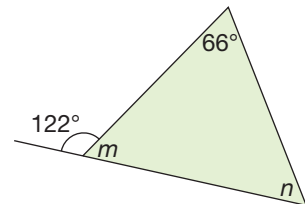

9. Find the measures of the angles labelled x and y .

Show your work. Explain the strategy you used.

a)

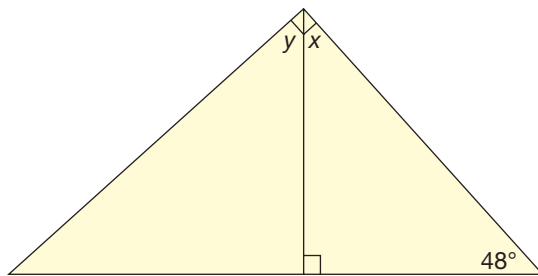

b)

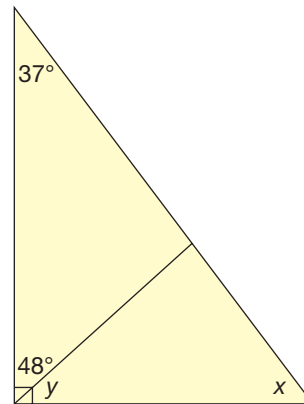

10. Use a geoboard and geobands or square dot paper.

Construct $\triangle ABC$.

a) Find the unknown angle measures.

Check your answers by measuring with a protractor.

b) Extend AB 1 unit right to D .

Extend AC 1 unit down to E . Join DE .

c) Predict the measure of each angle in the new triangle.

Use a protractor to check. Record your work.

d) Repeat steps b and c two more times.

e) What do you notice about all the triangles you created? Explain.

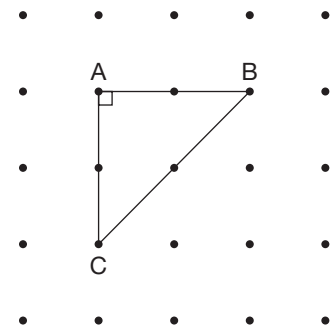

Reflect

Suppose your classmate missed today's lesson.
Explain how you know the sum of the angles in any triangle.

Investigating Angles in a Quadrilateral

How are these quadrilaterals alike?
How are they different?

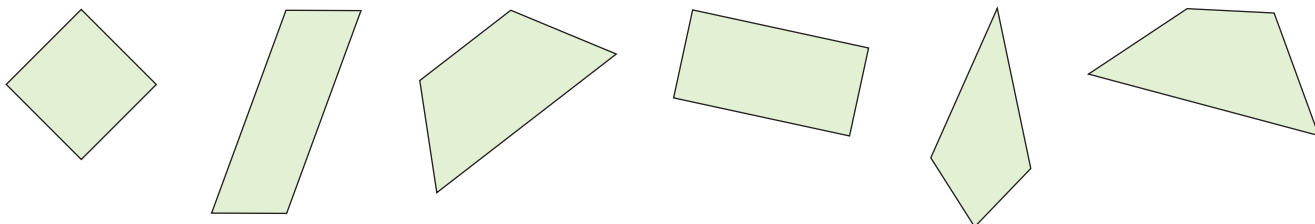

Explore



You will need a geoboard, geobands, a ruler, and square dot paper.
Draw each shape you make on dot paper.

- Make a square.
What do you know about each interior angle?
What is the sum of the angles in a square?
- Make a rectangle.
What do you know about each interior angle?
What is the sum of the angles in a rectangle?
- Make 2 different quadrilaterals.
None of the angles can be right angles.
Suppose you don't have a protractor.
How can you find the sum of the angles in each quadrilateral?
- What can you say about the sum of the angles in a quadrilateral? Explain.

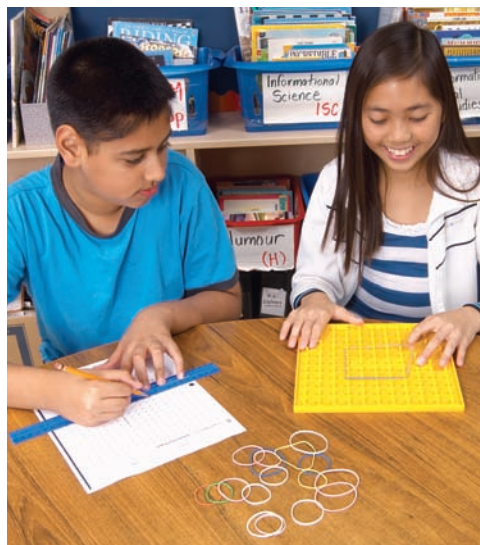

Show and Share

Compare your results with those of another pair of students.
How can you use what you know about triangles to find the sum of the angles in a quadrilateral?
Do you think this is true for all quadrilaterals? Why or why not?

Connect

- The sum of the interior angles in a quadrilateral is the same for any quadrilateral.

A **diagonal** divides any quadrilateral into 2 triangles.

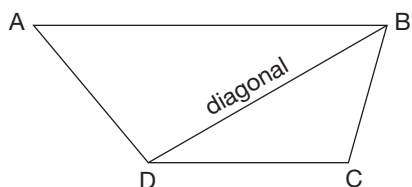

We can use 3 letters to name an angle. The middle letter tells the vertex of the angle.



The sum of the angles in each triangle formed is 180° .

In $\triangle ABD$, $\angle ABD + \angle BDA + \angle DAB = 180^\circ$

In $\triangle DBC$, $\angle DBC + \angle BCD + \angle CDB = 180^\circ$

So, the sum of the angles in quadrilateral ABCD is $2 \times 180^\circ = 360^\circ$.

- We can use the sum of the angles in a quadrilateral to find the measure of $\angle S$ in quadrilateral PQRS.

The sum of the angles in a quadrilateral is 360° .

So, $\angle P + \angle Q + \angle R + \angle S = 360^\circ$

Since $\angle P = 68^\circ$, $\angle Q = 126^\circ$, and $\angle R = 106^\circ$,

$68^\circ + 126^\circ + 106^\circ + \angle S = 360^\circ$ Add the angles.

$300^\circ + \angle S = 360^\circ$

Solve the equation by inspection.

Which number do we add to 300 to get 360?

The measure of $\angle S$ is 60° .

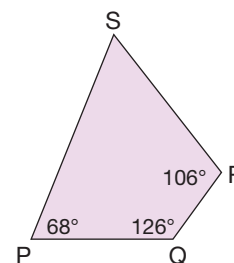

Practice

1. Draw 3 different quadrilaterals on dot paper.
Measure and record each angle.
Find the sum of the measures of the angles for each quadrilateral.

2. Find the unknown angle measure in each quadrilateral.

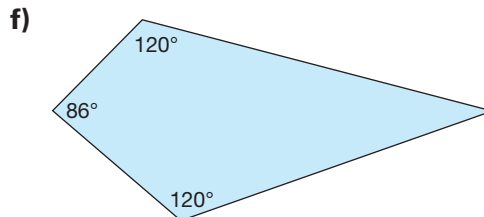
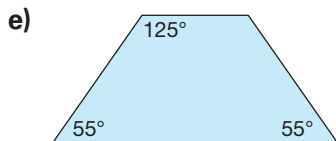
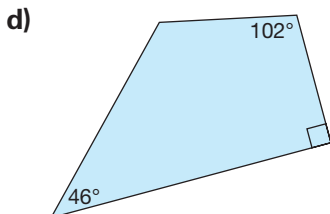
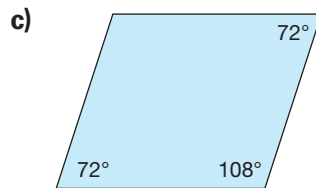
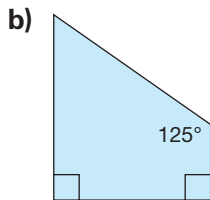
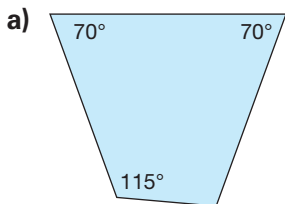

3. A student drew 4 different quadrilaterals. She recorded the angle measures in a table.

Quadrilateral	$\angle A$	$\angle B$	$\angle C$	$\angle D$
a)	225°	36°	47°	42°
b)	81°	99°	81°	99°
c)	90°	45°	120°	105°
d)	123°	66°	108°	73°

Did the student measure the angles in each quadrilateral correctly? How do you know?



4. Use a geoboard and geobands and/or dot paper.

Try to make each quadrilateral below.

If you can make the quadrilateral, record your work on dot paper.

If you cannot make the quadrilateral, use what you know about the sum of the angles in a quadrilateral to explain why.

- a) a quadrilateral with 4 right angles
- b) a quadrilateral with 2 acute angles and 2 obtuse angles
- c) a quadrilateral with only one right angle
- d) a quadrilateral with 4 acute angles
- e) a quadrilateral with 4 obtuse angles

5. Look at this pentagon.

- a) Find the measure of $\angle A$.
- b) Find the measure of $\angle DBC$.

Show your work. Explain your thinking.

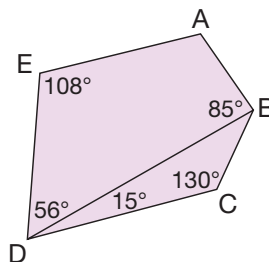

6. Find the measure of the angles labelled a , b , and c .

Show your work.

a)

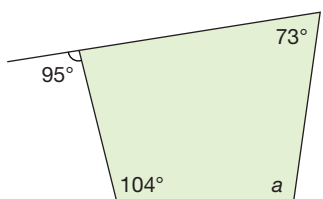

b)

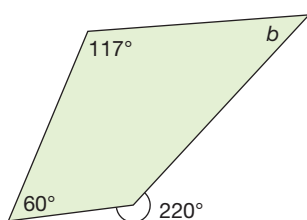

c)

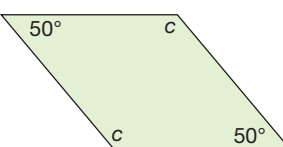

7. Find the measure of $\angle ABC$.

Show all the steps you took to find its measure.

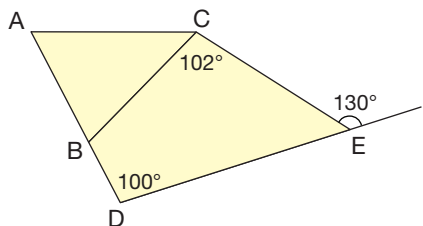

8. Draw a rectangle. Draw its diagonals.

Measure one of the angles formed where the diagonals intersect.

Without using a protractor, find the measures of the other 3 angles.

Explain your strategy.

Repeat for 2 different quadrilaterals.

What do you notice?

9. Look at parallelogram ABCD.

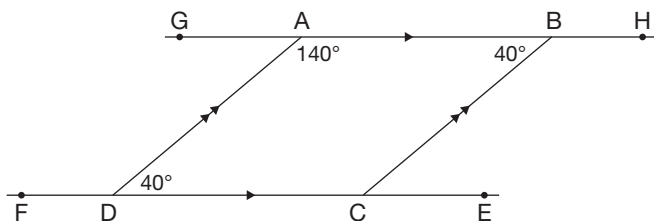

- Without using a protractor, find the measure of $\angle BCD$.
- Find the measure of $\angle BCE$, $\angle CBH$, $\angle ADF$, and $\angle DAG$.
What strategy did you use?
- List pairs of angles that have the same measure.
- List pairs of angles that add to 180° .

Reflect

How did you use what you know about the sum of the angles in a triangle in this lesson?

LESSON

- 1** 1. Identify as many different angles as you can in the signs below. Name each angle as acute, obtuse, right, straight, or reflex. Tell how you know. Describe the location of each angle.

a)



Iqaluit, Nunavut

b)



Northwest Territories

c)



Jasper National Park, Alberta

2. Draw a line segment on grid paper. Visualize rotating the line segment about one of its end points. Which type of angle is formed by each rotation?
- $\frac{1}{4}$ turn clockwise
 - between a $\frac{1}{2}$ turn and a full turn clockwise
 - between a $\frac{1}{4}$ turn and a $\frac{1}{2}$ turn counterclockwise
 - less than a $\frac{1}{4}$ turn counterclockwise
- Use tracing paper to check.

- 3** 3. Owen says he can make an angle smaller by making the arms shorter. Do you agree? Why or why not?
4. For each angle:
- Choose an appropriate reference angle: 45° , 90° , 180°
 - Estimate the size of the angle.
 - Use a protractor to measure each angle.
 - Order the angles from least to greatest measure.
 - Name each angle as acute, right, obtuse, straight, or reflex.

a)

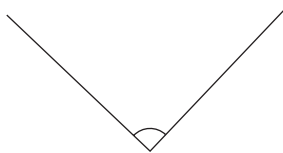

b)

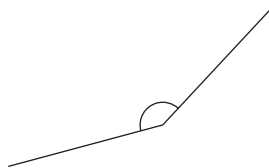

c)

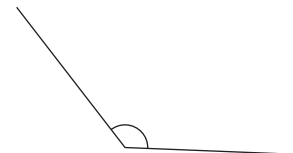

d)

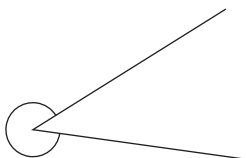

e)

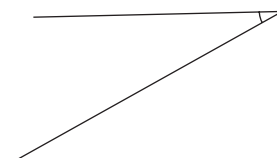

f)

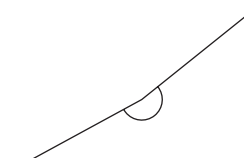

LESSON

5. A student used a protractor to measure this angle. The student says the angle measures 65° . Is the student correct? If your answer is yes, explain how you know. If your answer is no, describe the student's mistake.

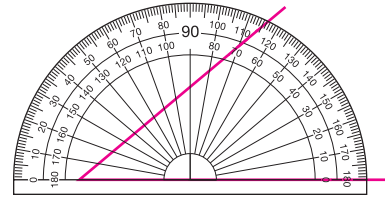

- 4
6. a) Use a protractor to draw a 40° angle.
 b) Do not use a protractor. Draw an angle that is 90° greater. Describe the strategy you used.
 c) Use a protractor to check the angle in part b.

7. Copy these line segments. Use a ruler and a protractor. Using each line as one arm, draw a 125° angle.

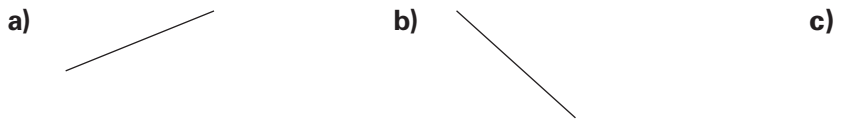

Does the position of an angle on the page affect its measure? Explain how you know.

- 6
8. Use a ruler and a protractor.
- a) Draw, then label each angle below with its measure:
- a right angle
 - an acute angle
 - an obtuse angle
- b) For each angle in part a:
- Join the arms together to make a triangle.
 - Measure and label one of the other angles.
 - Without using a protractor, label the third angle with its measure.
- c) Explain the strategy you used to find the measure of the third angle each time.

9. Two angles of a triangle are given. Find the measure of the third angle.
- a) $70^\circ, 25^\circ$ b) $62^\circ, 71^\circ$ c) $58^\circ, 74^\circ$ d) $115^\circ, 43^\circ$

- 7
10. A quadrilateral has angles measuring $60^\circ, 50^\circ,$ and 120° . What is the measure of the 4th angle? How do you know?

UNIT

4

Learning Goals

- name, describe, and classify angles
- estimate and determine angle measures
- draw and label angles
- provide examples of angles in the environment
- investigate the sum of angles in triangles and quadrilaterals

Unit Problem

Designing a Quilt Block

You will need:

- square grid paper
- large piece of paper (30 cm by 30 cm)
- scissors
- glue or tape
- construction paper
- rulers
- protractors

A quilt is usually made in square sections called blocks. Here are some examples of quilt blocks.

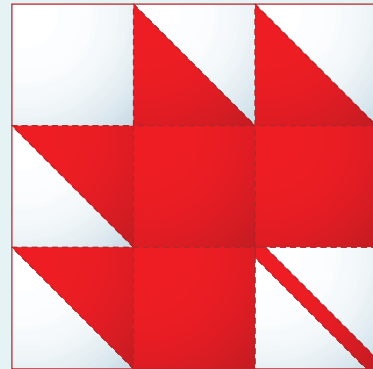
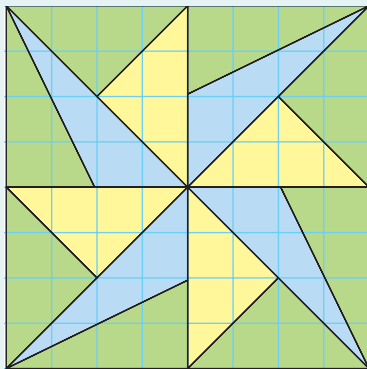

Part 1

Design your own quilt block.

Use a sheet of square grid paper.

Make a square pattern for your quilt block.

Your pattern should include triangles and quadrilaterals.

Part 2

To reproduce your pattern on a large piece of paper:

Use a ruler and a protractor to draw the shapes you used on different colours of construction paper. Cut out the shapes.

Glue or tape the shapes onto the large sheet of paper.

Use pencil crayons or markers to add more colour to your block.

Check List

Part 3

Write about your block.

Describe at least one example of each type of angle:

- acute angle
- obtuse angle
- right angle
- reflex angle
- straight angle

Include the angle measure of each angle you chose.

Describe how you can use angles in your block to show the sum of the angles in a triangle and in a rectangle.

Your work should show:

- an appropriate pattern on grid paper
- your understanding of the sum of angles
- accurate descriptions of angles
- correct use of geometric language

Part 4

Combine your block with those of other groups to make a bulletin board quilt.



Reflect on Your Learning

Write about what you have learned about angles, triangles, and quadrilaterals. Use diagrams and words to explain.

Investigation

Ziggurats



Ziggurats were built by the ancient Assyrians and Babylonians.

A ziggurat is a tiered pyramid that was used as a temple.

Each tier of a ziggurat is smaller than the one below it.



Tiers are layers arranged one on top of another.

You will need linking cubes, triangular dot paper, and grid paper.

Part 1

- Use linking cubes.
Build a ziggurat with each number of tiers:
1 tier 2 tiers 3 tiers
Each tier is centred on the tier below it.

Each block covers the block below it.



You can do this.



You cannot do this.



- Draw each ziggurat on triangular dot paper.



- Predict the number of cubes required to build a 4-tier ziggurat. Build it to check your prediction.

Part 2

- Find the volume of each ziggurat in Part 1. Record the numbers of tiers and the volumes in a table.

Number of Tiers	Volume
1	
2	

Graph the table of values.

Explain how the graph represents the pattern.

Write a pattern rule for the volumes.

- Use the pattern rule. What is the volume of a 6-tier ziggurat? Explain.



Display Your Work

Create a summary of your work. Describe all the patterns you used. Use pictures, numbers, and words.

Take It Further

Suppose you built staircases like this one.

Predict a pattern rule for the volumes of staircases with different numbers of tiers.

Build the staircases to check your prediction.

Draw each staircase on triangular dot paper.

